



Teca



DELLA MARTA  
ITALY



# TECA

**VETRINE UFFICIALI**  
*OFFICIAL WINE COOLER*



**Associazione Italiana Sommelier**

La Teca si presenta sobria ed elegante, volutamente minimalista ed essenziale. L'ampia superficie vetrata mette in risalto l'originale esposizione orizzontale delle bottiglie, creando una suggestiva scenografia. L'impianto di refrigerazione centrale non altera gli equilibri estetici, si integra in modo discreto e, come per magia, assume la forma di un elegante portabottiglie.

Le temperature differenziate consentono di conservare sia vini bianchi che vini rossi a una temperatura ideale, con la garanzia che ogni bottiglia sia sempre pronta per ogni occasione.

La Teca è la punta di diamante della collezione, diventata icona del brand Della Marta nel mondo.

Teca is sober and elegant, deliberately minimalistic and essential. Its broad glass surface emphasizes the original horizontal bottle display, creating a suggestive scene. The refrigeration system does not alter its aesthetic balance, it integrates discreetly and – with a touch of magic – turns into an elegant bottle holder.

Differentiated temperatures allow both white and red wines to be stored at an ideal temperature, with the assurance that each bottle is always ready for any occasion.

Teca is the most valued asset of our collection, and has become global icon of the Della Marta brand.



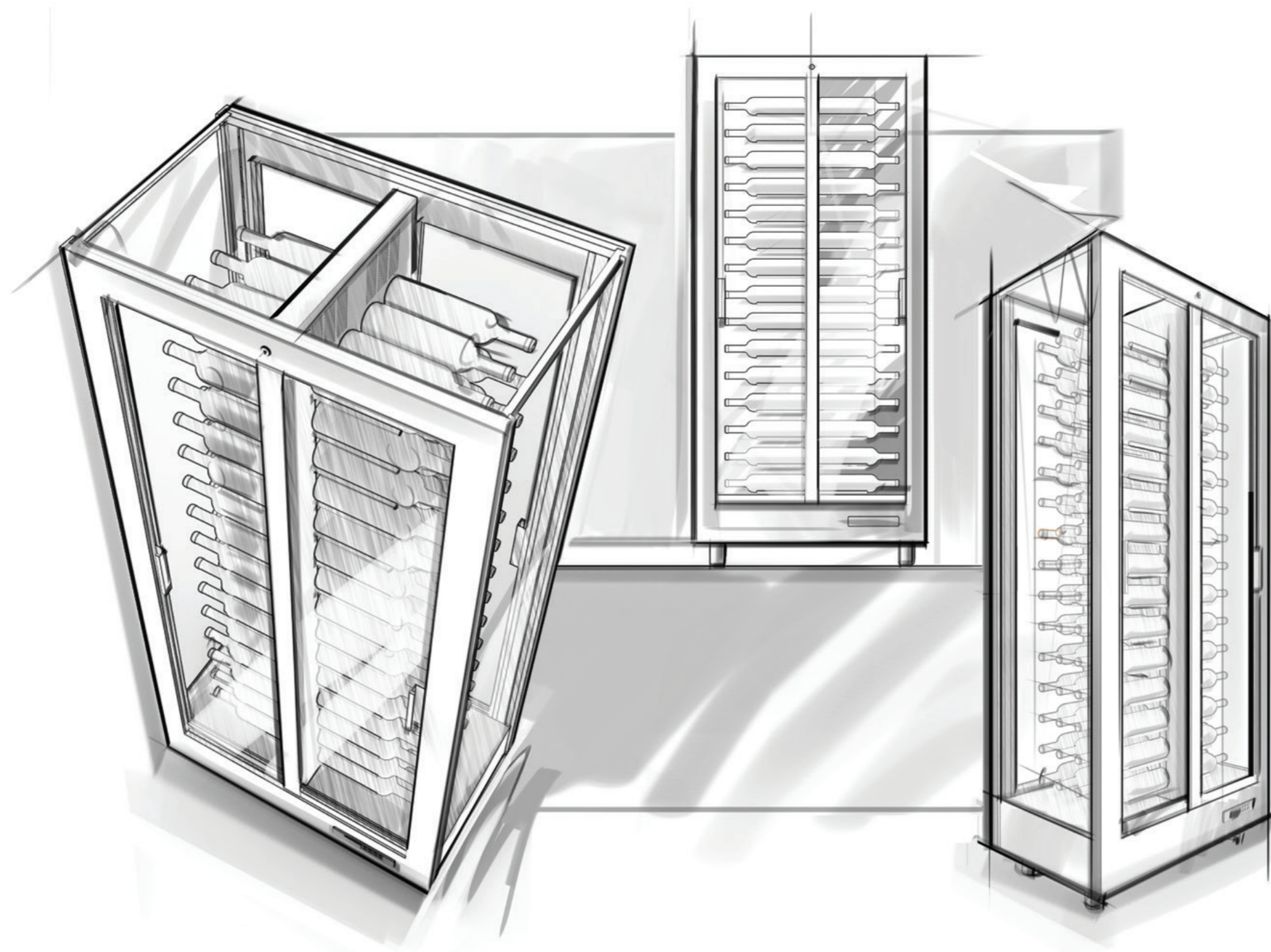

Q



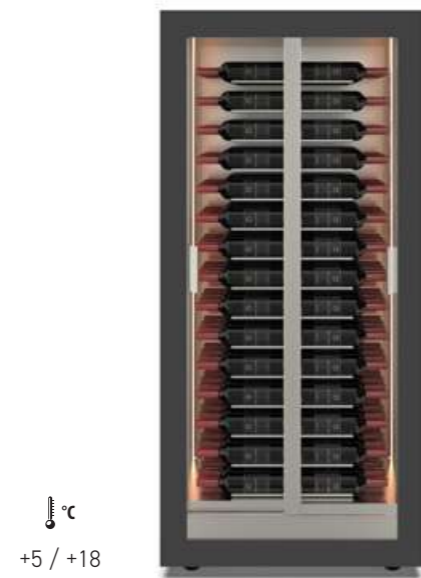

+5 / +18

TECA 10

  
 Bottiglie orizzontali  
 Horizontal bottles

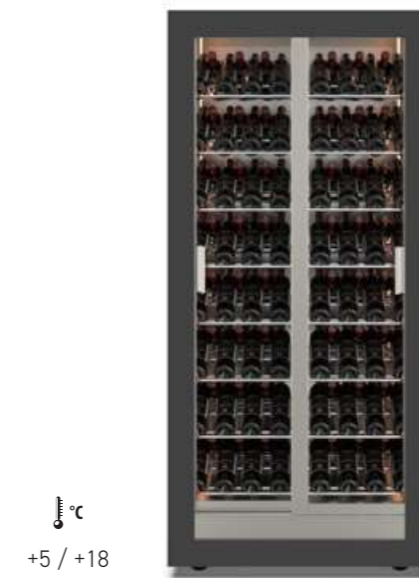

+5 / +18

TECA 12

  
 Bottiglie inclinate  
 Tilted bottles

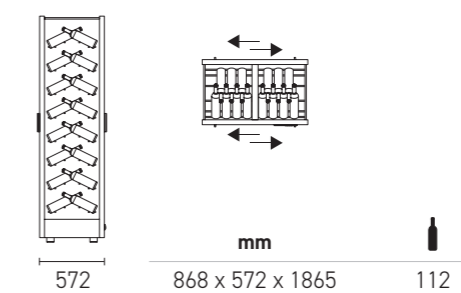
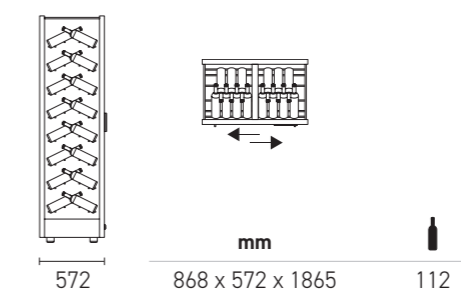
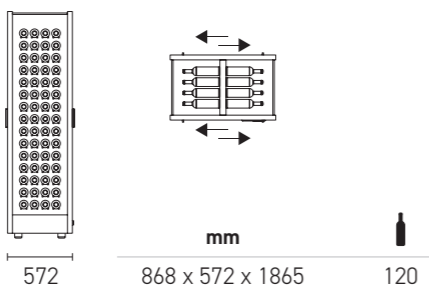
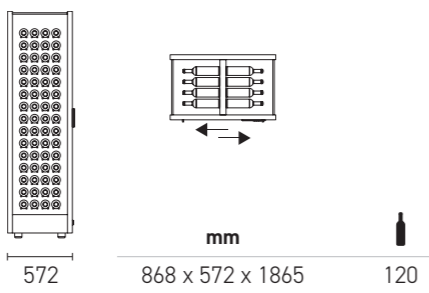
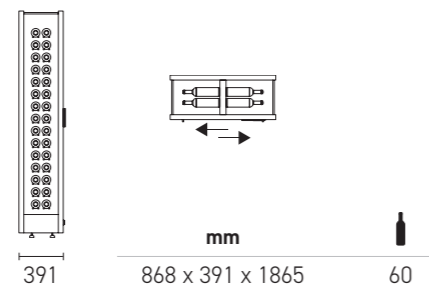





 °C  
 +5 / +18

TECA 13

  
 Piani regolabili ogni 5 cm  
 Adjustable shelves every 5 cm



 °C  
 +5 / +18

TECA 14

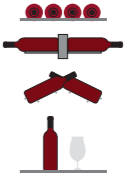
  
 Allestimento interno personalizzabile  
 Custom internal layout

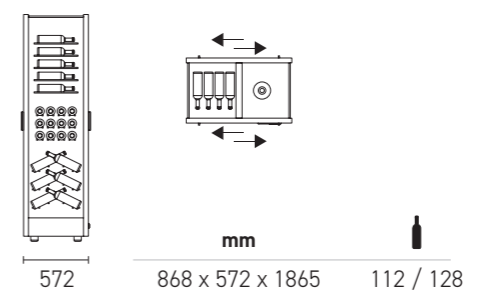
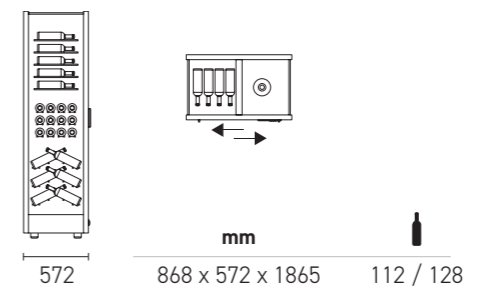
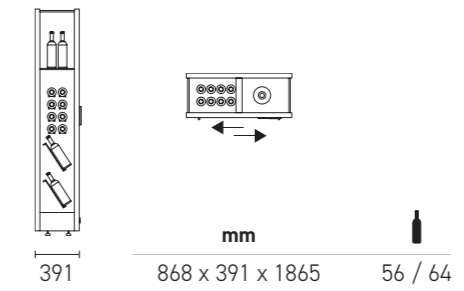
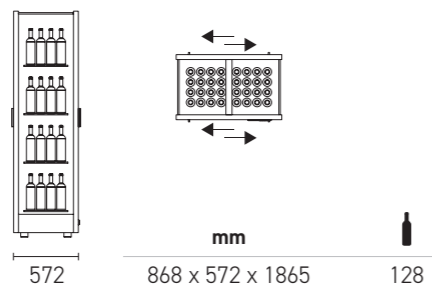
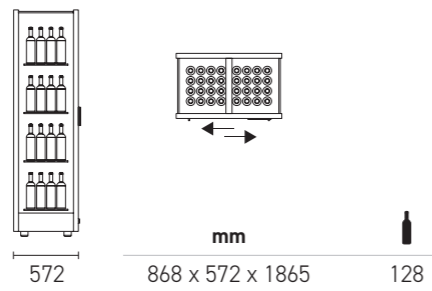



°C  
+14 / +16



**TECA 17**  
*Ciocolato / Chocolate*



391

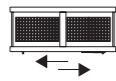

mm  
868 x 391 x 1865



572

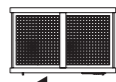

mm  
868 x 572 x 1865



572

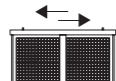

mm  
868 x 572 x 1865

°C  
+5 / +18



**TECA 18**  
*Gatonomia / Delicatessen*



391

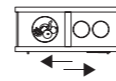

mm  
868 x 391 x 1865



572

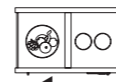

mm  
868 x 572 x 1865



572

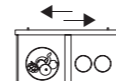

mm  
868 x 572 x 1865

°C  
+5 / +18



**TECA 19**  
*Salumeria / Salami and cheese*



572

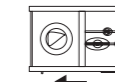

mm  
868 x 572 x 1865



572

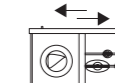

mm  
868 x 572 x 1865



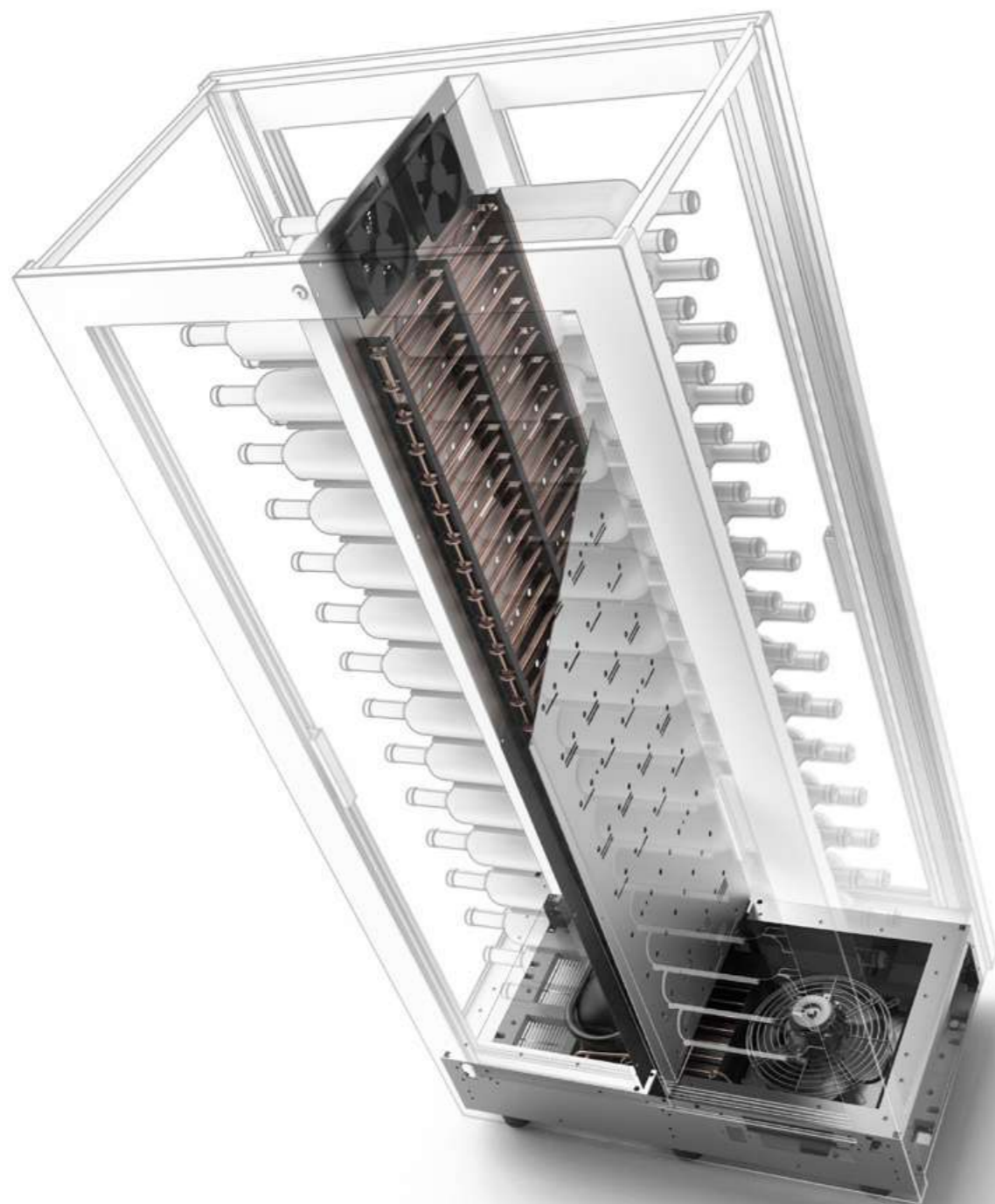

## CENTRAL COOLING SYSTEM (PATENTED)



Rappresenta una rivoluzione nel campo della termodinamica applicata. È il primo frigorifero al mondo con serpentina di evaporazione al centro del vano refrigerato, un perfetto equilibrio termico.

L'evaporatore diventa un supporto. Tutte le bottiglie sono poste alla stessa distanza dalla fonte del freddo.

Si tratta di un'intuizione che ha aperto la strada ad una nuova concezione di progettazione e costruzione, capace di valorizzare nuovi volumi e creare inattese trasparenze.

*A revolution in applied thermodynamics.*

*The first refrigerator in the world with an evaporation coil in the middle of the refrigerated compartment, a perfect thermal balance.*

*The evaporator becomes a support. All bottles are at the same distance from the source of cold.*

*An insight that paved the way to a new concept in design and construction, adding value to new volumes and creating unexpected transparencies.*



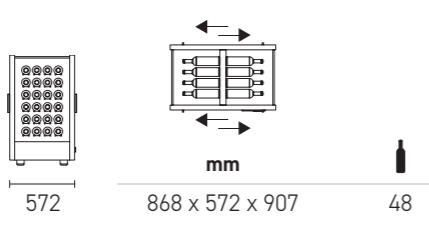
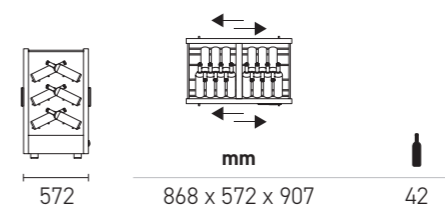
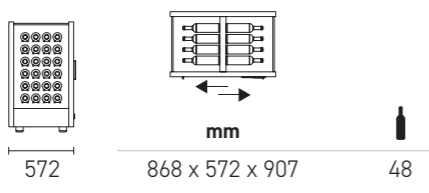
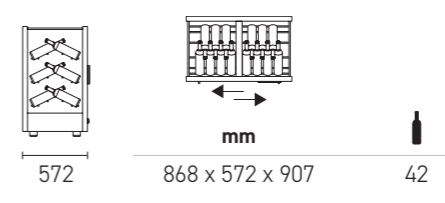
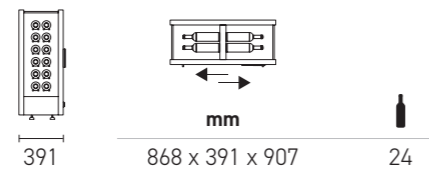



TECA 23

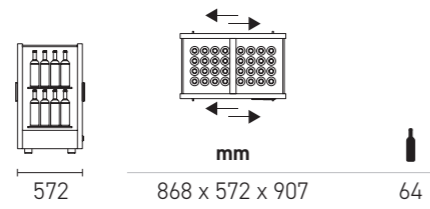
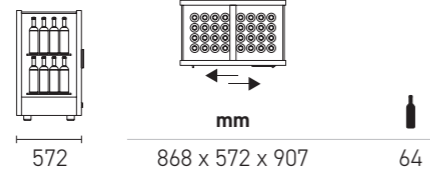

TECA 24

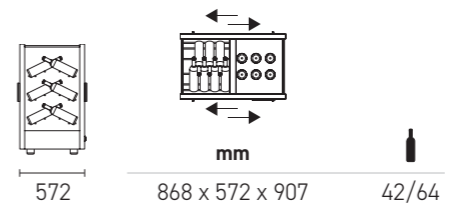
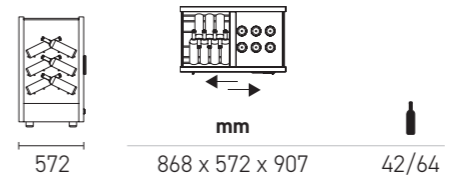
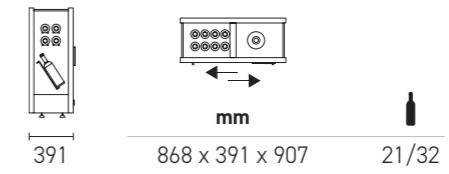
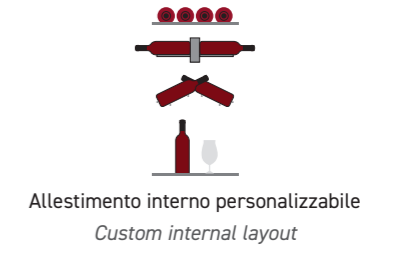



°C  
+14 / +16



**TECA 27**  
*Cioccolato / Chocolate*

°C  
+5 / +18



**TECA 28**  
*Gatonomia / Delicatessen*

°C  
+5 / +18



**TECA 29**  
*Salumeria / Salami and cheese*

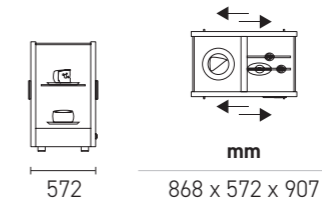
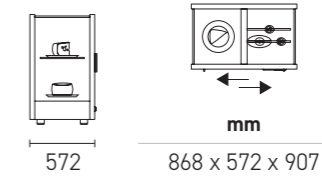
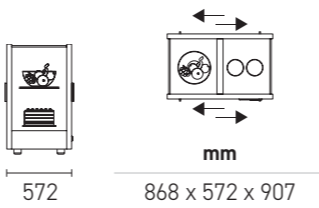
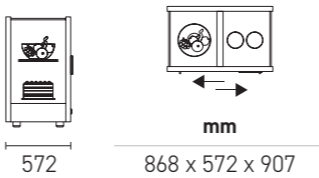
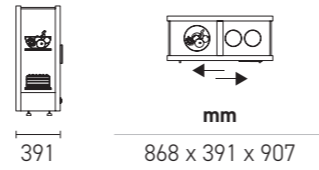
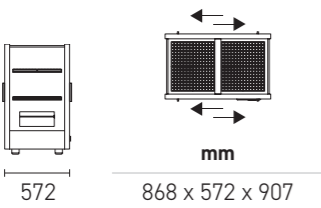
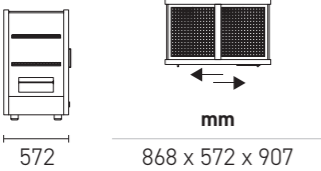
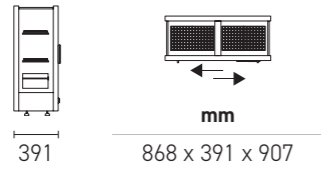





### FILTRO A CARBONI ATTIVI | ACTIVATED CHARCOAL FILTER

Cambiare spesso i carboni è importante per mantenere un corretto microclima all'interno della vetrina. Il filtro a carboni attivi ricaricabile consente la facile sostituzione dei carboni senza dover necessariamente sostituire l'intero filtro. I carboncini esausti possono essere conferiti nell'organico. Una soluzione nel segno della massima sostenibilità ambientale.

Changing carbons often is important to maintain an appropriate microclimate inside the cabinet. Rechargeable activated carbon filter lets you easily swap carbons without necessarily changing the whole filter. Exhausted carbons can be disposed of as organic waste. A solution in the name of maximum environmental sustainability.



### APP DELLA MARTA | DELLA MARTA APP

È un'applicazione per il monitoraggio ed il controllo wireless dei prodotti Della Marta. L'app permette all'utente di usufruire dei servizi di report settimanale e di alert tramite messaggi push e via mail. È possibile controllare e modificare, anche a distanza ed in tempo reale, le temperature e le impostazioni delle vetrine. Grazie a questo sistema di connessione sempre attivo, la vetrina viene monitorata e consente di ricevere supporto tecnico, tramite diagnostica, in qualsiasi parte del mondo il prodotto si trovi. L'applicazione Della Marta è disponibile su Play Store e App Store.

Is an app for wireless remote monitoring and control of Della Marta products. This app allows the user to view weekly reports and receive push and email alerts. It allows to control and edit, remotely and in real time, temperature and settings of the cabinets. Thanks to this always-running connection system, the cabinet is monitored and remote technical support – through diagnostics – can be provided anywhere in the world. Della Marta is available on the App Store and Play Store.



### CONFIGURATORE ONLINE | ONLINE CONFIGURATOR

Il configuratore online permette di progettare composizioni di vetrine singole o multiple, con installazione free standing oppure a incasso. È possibile scegliere finiture interne ed esterne, cornici e cover in diversi colori, personalizzando ogni dettaglio. Al termine si ottiene un progetto completo di immagini, schede tecniche e disegni, che consente di valutare la soluzione più adatta alle proprie esigenze progettuali.

The online configurator allows you to design single or multi-unit display case layouts, available for either freestanding or built-in installation. You can customize every detail, choosing from various interior and exterior finishes, frames, and covers in multiple colours. Upon completion, you will receive a comprehensive project summary including images, technical data sheets, and drawings, helping you evaluate the perfect solution for your design needs.

### CONTROLLO DELLE LUCI | LIGHTING CONTROL

Con il controller luci è possibile regolare l'illuminazione interna della vetrina, scegliendo intensità e colore in modalità RGB oppure luce bianca variabile, dal bianco caldo 2700 K al bianco freddo 6000 K. Una soluzione smart e intuitiva che permette di creare la giusta atmosfera, valorizzare le bottiglie di vino e adattare l'effetto luminoso a ogni ambiente o occasione.

With the light controller, you can adjust the display case's internal lighting by choosing the intensity and colour in RGB mode or tunable white light, ranging from a warm white (2700 K) to a cool white (6000 K). This smart, intuitive solution allows you to create the perfect atmosphere, highlight the wine bottles, and adapt the lighting effect to any environment or occasion.

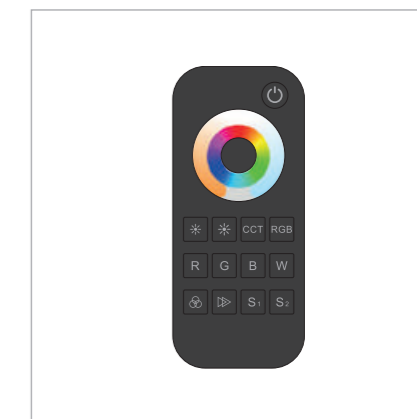

### UNITÀ REFRIGERANTE REMOTA | REMOTE COOLING UNIT

Tutte le vetrine della collezione Teca possono essere predisposte per il collegamento a un'unità refrigerante remota. Questa soluzione, ideale per composizioni con più vetrine, permette di realizzare installazioni di grandi dimensioni mantenendo elevato il comfort dell'ambiente. Il sistema garantisce la massima silenziosità offrendo una gestione efficiente della refrigerazione.

All display cases in the Teca collection can be pre-configured for connection to a remote cooling unit. Ideal for multi-unit configurations, this solution allows for large-scale installations while maintaining maximum room comfort. The system ensures whisper-quiet operation and delivers highly efficient refrigeration management.

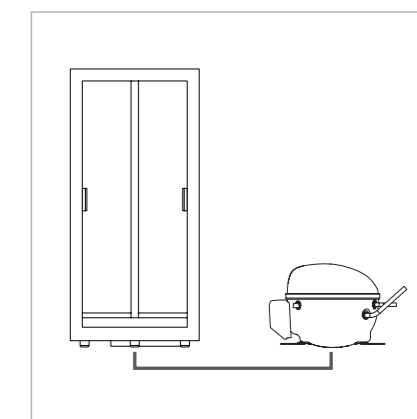

### PORTE SCORREVOLI | SLIDING DOORS

Il sistema di apertura delle vetrine Teca è caratterizzato da eleganti porte scorrevoli, una soluzione esclusiva che unisce design, praticità e raffinatezza. Diversamente dalle aperture tradizionali, questa soluzione valorizzando l'estetica della vetrina facilitando l'accesso alle bottiglie. La doppia porta per ogni lato aumenta la funzionalità, riduce la dispersione termica e rende l'esperienza d'uso ancora più elegante e professionale.

The opening system of Teca display cases features elegant sliding doors, an exclusive solution that combines design, practicality, and refinement. Unlike traditional openings, this solution enhances the showcase's aesthetics while facilitating access to the bottles. The double door on each side increases functionality, reduces heat loss, and makes the user experience even more elegant and professional.



## FINITURE INTERNE E PORTE | INTERIOR FINISHES AND DOORS

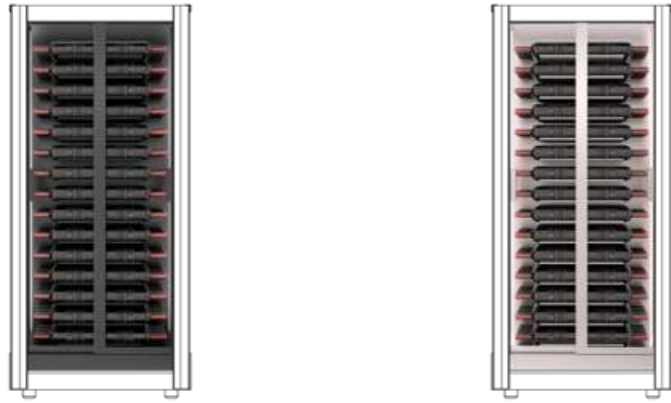

ALLUMINIO  
ALUMINUM



AA01 anodizzato argento  
silver anodised  
AV05 verniciato nero  
black painted

## FINITURE ESTERNE | EXTERIOR FINISHES

La Teca può essere rivestita con diverse tipologie di cornici e cover disponibili in molti colori e facilmente sostituibili.  
Teca can be completed with various types of frames and covers available in many colors and easily replaceable.

Cornice di finitura | Finishing frame

Cover

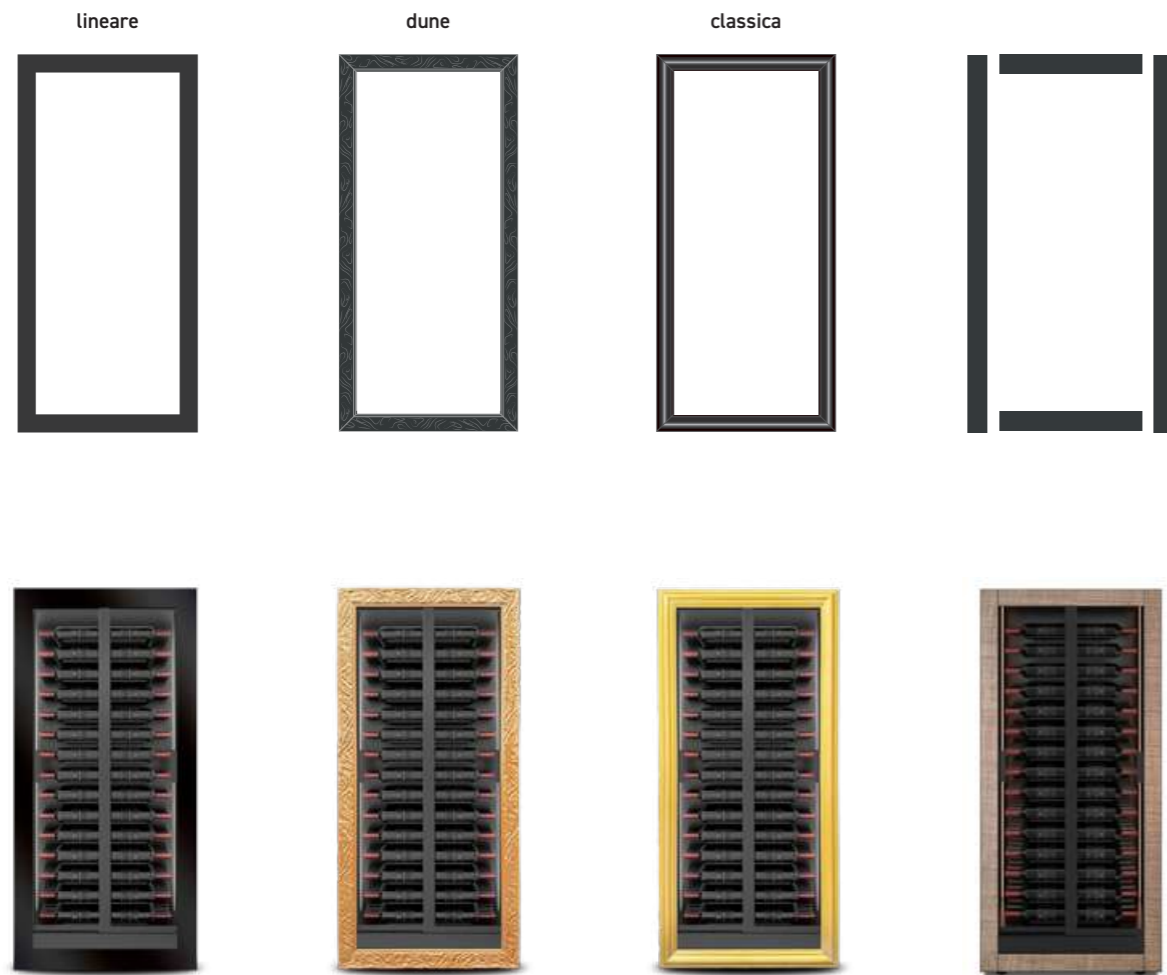

MDF/ALLUMINIO

cornice lineare  
linear frame



L-GR non verniciato  
unpainted



AV05 verniciato nero  
black painted

AYOUS

cornice dune  
dune frame



D-GR non verniciato unpainted  
D-RAL9010 bianco opaco matte white  
D-RAL9005 nero opaco matte black  
D-LM01 oro gold  
D-LM02 argento silver  
D-LM03 bronzo bronze  
D-LM04 oro tenue soft gold  
D-LM05 oro rosa rose gold  
D-LM06 perla pearl

AYOUS

cornice classica  
classic frame

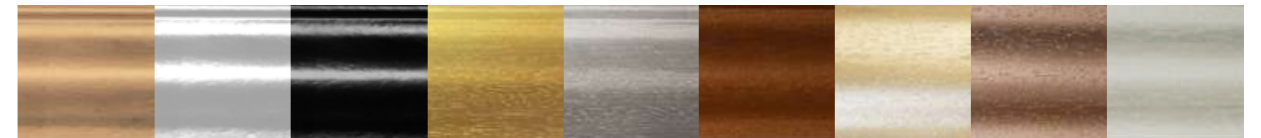

C-GR non verniciata unpainted  
C-RAL9010 bianco opaco matte white  
C-RAL9005 nero opaco matte black  
C-LM01 oro gold  
C-LM02 argento silver  
C-LM03 bronzo bronze  
C-LM04 oro tenue soft gold  
C-LM05 oro rosa rose gold  
C-LM06 perla pearl

HPL  
laminato alta pressione  
high pressure laminate

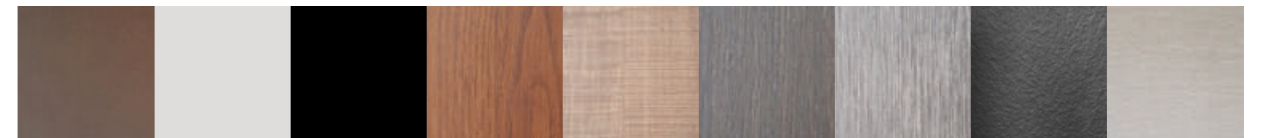

L01 grezzo raw  
L10 bianco opaco matte white  
L11 nero opaco matte black  
L20 castagno chestnut  
L21 teak roble teak roble  
L22 wengé loft wenge loft  
L23 larice cenere ash larch  
L30 nero materico black textured  
L40 cemento tortora taupe cement

cover



L42 corten  
L50 acciaio satinato satin steel  
L51 oro satinato satin gold  
L52 bronzo satinato satin bronze  
L53 nero satinato satin black

MDF  
DUNE  
CLASSICA  
HPL



RAL 20  
opaco 20 gloss  
matte 20 gloss



DELLA MARTA

Factory: Via G. Di Vittorio, 11 · 10098 Rivoli (TO) · ITALY

Flagship store: Via Pietro Maroncelli, 5 · 20154 Milano · ITALY

[www.dellamarta.it](http://www.dellamarta.it) · [info@dellamarta.it](mailto:info@dellamarta.it)

